

**LED DISPLAY  
LTD-4830CTB-P**

**LED DISPLAY**

LTD-4830CTB-P

<u>Rev</u>	<u>Description</u>	<u>By</u>	<u>Date</u>
01	Preliminary Spec.	Reo Lin	04/20/2011
02	Add minimum packing quantity in page 12	Reo Lin	05/08/2014
<b>Above data for PD and Customer tracking only</b>			

## LED DISPLAY LTD-4830CTB-P

### 1. Description

The LTD-4830CTB-P is a 0.39 inch (10.0mm) digit height dual digit SMD display. This device uses InGaN blue LED chips (InGaN epi on Sapphire substrate). The display has gray face and white segments.

#### 1.1 Features

- 0.39 inch (10.0 mm) DIGIT HEIGHT
- CONTINUOUS UNIFORM SEGMENTS
- LOW POWER REQUIREMENT
- EXCELLENT CHARACTERS APPEARANCE
- HIGH BRIGHTNESS & HIGH CONTRAST
- WIDE VIEWING ANGLE
- SOLID STATE RELIABILITY
- CATEGORIZED FOR LUMINOUS INTENSITY.
- LEAD-FREE PACKAGE (ACCORDING TO ROHS)

#### 1.2 Device

Part No	Description
InGaN Blue	Common Anode
LTD-4830CTB-P	Rt. Hand Decimal

## LED DISPLAY LTD-4830CTB-P

### 2. Package Dimensions

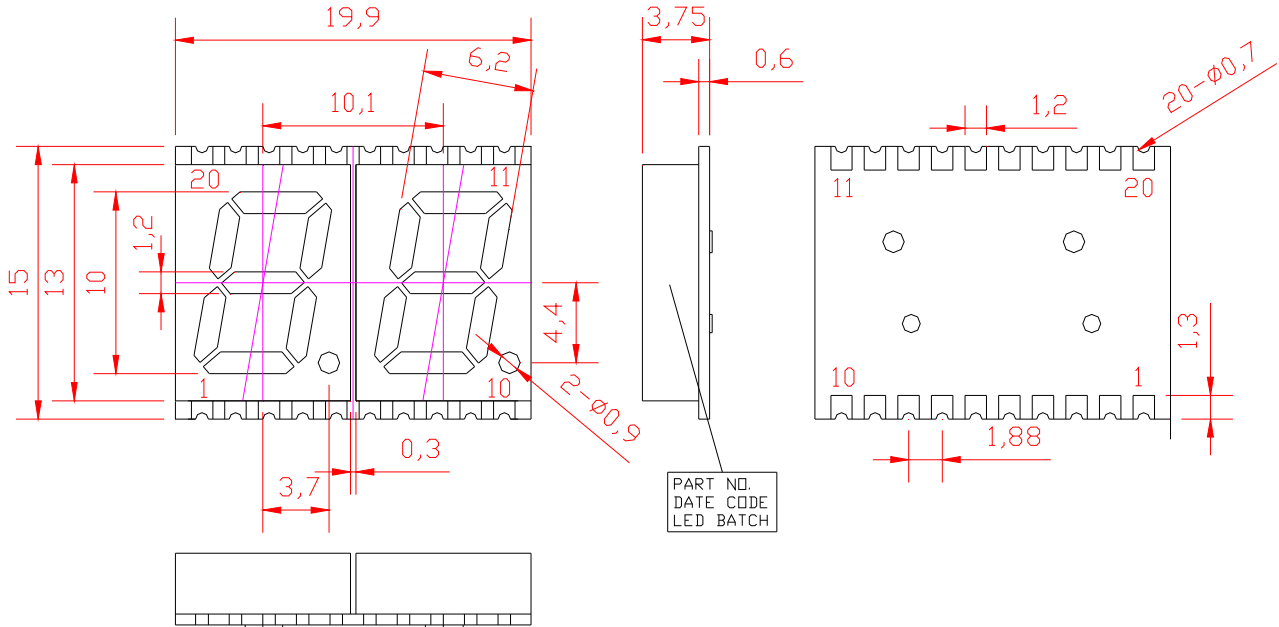

#### Notes :

1. All dimensions are in millimeters. Tolerances are  $\pm 0.25$  mm (0.01") unless otherwise noted
2. Foreign material on segment  $\leq 10$ mil
3. Ink contamination (surface)  $\leq 20$ mils
4. Bubble in segment  $\leq 10$ mil
5. Bending  $\leq 1\%$  of reflector length
6. Plastic pin's burr max is 0.05 mm

**LED DISPLAY  
LTD-4830CTB-P**

**3. Internal Circuit Diagram**

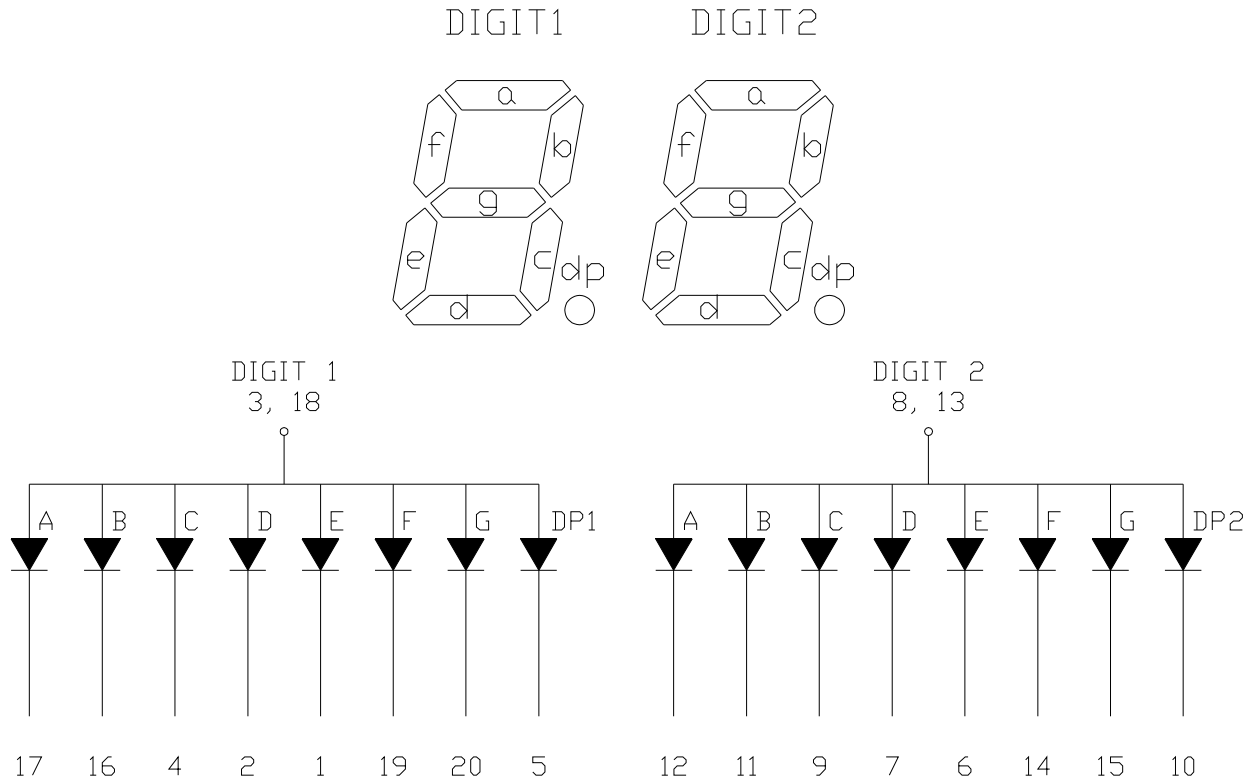

**LED DISPLAY  
LTD-4830CTB-P**

**4. Pin Connection**

No	Connection
1	CATHODE DIGIT1 E
2	CATHODE DIGIT1 D
3	COMMON ANODE DIGIT 1
4	CATHODE DIGIT1 C
5	CATHODE DIGIT1 DP
6	CATHODE DIGIT1 B
7	CATHODE DIGIT1 A
8	COMMON ANODE DIGIT 1
9	CATHODE DIGIT1 F
10	CATHODE DIGIT1 G
11	CATHODE DIGIT2 E
12	CATHODE DIGIT2 D
13	COMMON ANODE DIGIT 2
14	CATHODE DIGIT2 C
15	CATHODE DIGIT2 DP
16	CATHODE DIGIT2 B
17	CATHODE DIGIT2 A
18	COMMON ANODE DIGIT 2
19	CATHODE DIGIT2 F
20	CATHODE DIGIT2 G

## LED DISPLAY LTD-4830CTB-P

### 5. Rating and Characteristics

#### 5.1. Absolute Maximum Rating at Ta=25°C

Parameter	Maximum Rating	Unit
Power Dissipation Per Segment	70	mW
Peak Forward Current Per Segment ( 1/10 Duty Cycle, 0.1ms Pulse Width )	100	mA
Continuous Forward Current Per Segment Derating Linear From 25°C Per Segment	20 0.21	mA mA/°C
Operating Temperature Range	-35°C to +105°C	
Storage Temperature Range	-35°C to +105°C	
Iron Soldering Conditions: 1/16 inch Below Seating Plane for 3 Seconds at 260°C		

#### 5.2. Electrical / Optical Characteristics at Ta=25°C

Parameter	Symbol	MIN.	TYP.	MAX.	Unit	Test Condition
Average Luminous Intensity Per Segment	IV	2100	7000		μcd	IF=10mA
Peak Emission Wavelength	λp		468		nm	IF=20mA
Spectral Line Half-Width	Δλ		25		nm	IF=20mA
Dominant Wavelength	λd		470		nm	IF=20mA
Forward Voltage Per Chip	VF		3.3	3.8	V	IF=20mA
Reverse Current Per Segment <sup>(2)</sup>	IR			100	μA	VR=5V
Luminous Intensity Matching Ratio (Similar Light Area)	IV-m			2:1		IF=10mA

#### Notes :

1. Luminous intensity is measured with a light sensor and filter combination that approximates the CIE (Commission International De L'Eclairage) eye-response curve
2. Reverse voltage is only for IR test. It cannot continue to operate at this situation
3. Cross talk specification  $\leq 2.5\%$

# LED DISPLAY LTD-4830CTB-P

### ESD (Electrostatic Discharge)

Static Electricity or power surge will damage the LED. Suggestions to prevent ESD damage:

- Use of a conductive wrist band or anti-electrostatic glove when handling these LEDs.
- All devices, equipment, and machinery must be properly grounded.
- Work tables, storage racks, etc. should be properly grounded.
- Use ion blower to neutralize the static charge which might have built up on surface of the LED's plastic for N/D as a result of friction between LEDs during storage and handling.

## LED DISPLAY LTD-4830CTB-P

### 5.3. Typical Electrical / Optical Characteristics Curves

(25°C Ambient Temperature Unless Otherwise Noted)

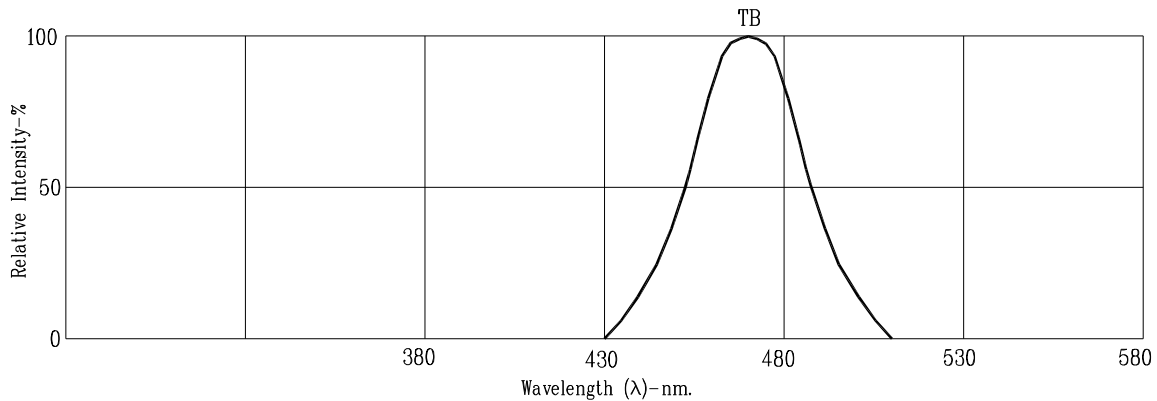

Fig1. RELATIVE INTENSITY VS. WAVELENGTH

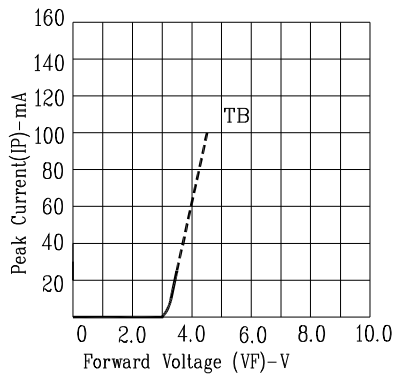

Fig3. FORWARD CURRENT VS. FORWARD VOLTAGE

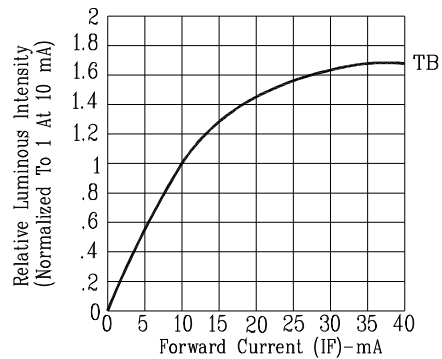

Fig4. RELATIVE LUMINOUS INTENSITY VS. FORWARD CURRENT

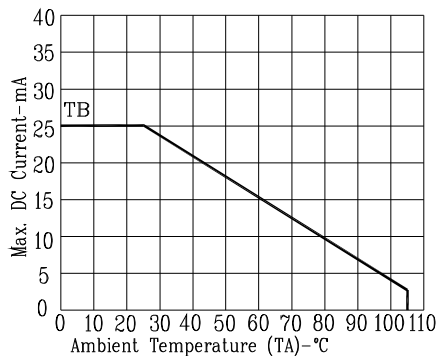

Fig5. MAX. ALLOWABLE DC CURRENT VS. AMBIENT TEMPERATURE.

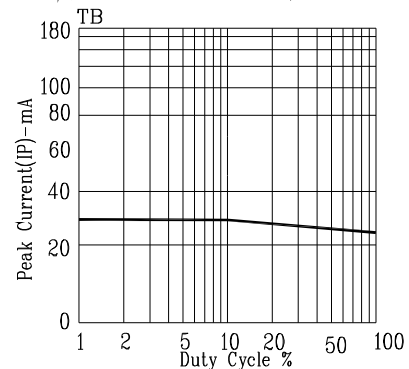

Fig6. MAX. PEAK CURRENT VS. DUTY CYCLE %  
(REFRESH RATE 1KHz)

NOTE: TB=InGaN/sapphire Blue



## LED DISPLAY LTD-4830CTB-P

### 6. SMT SOLDERING INSTRUCTION

(Number of reflow process shall be less than 2 times, and cooling process to normal temperature is required between the first and the second soldering process)

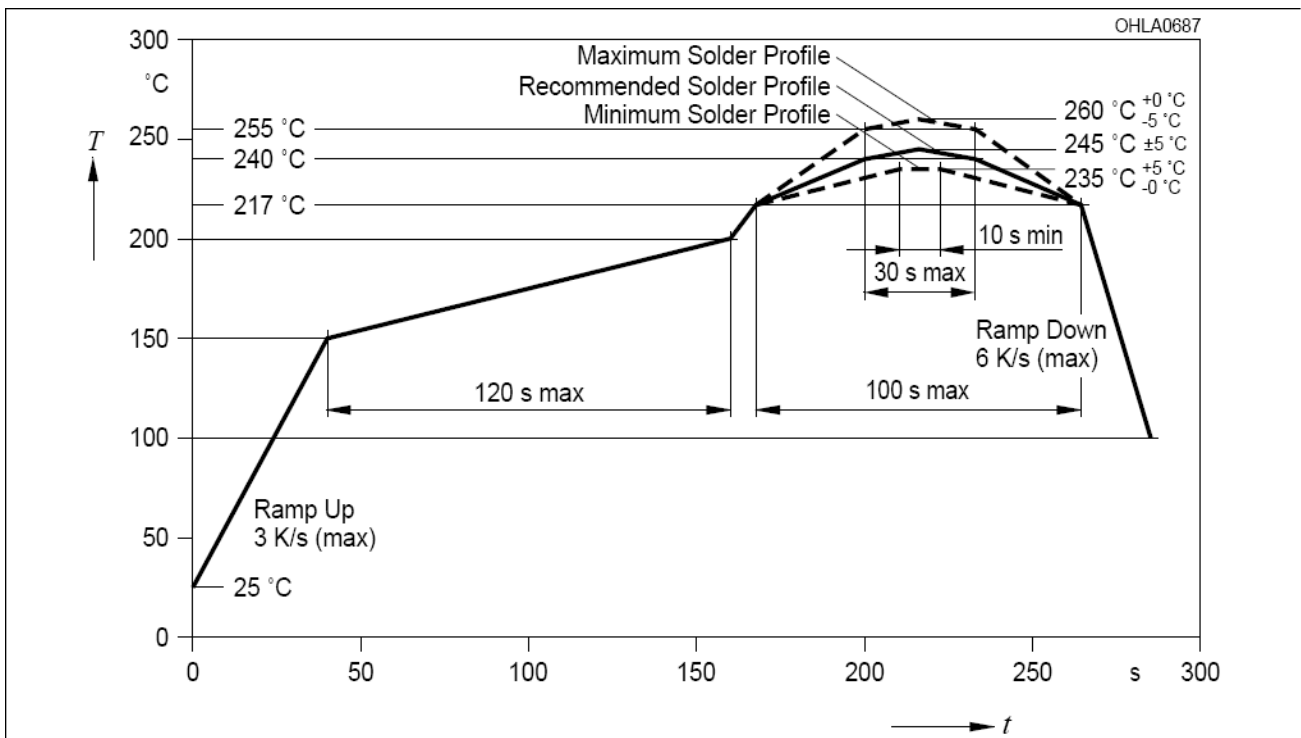

#### Notes :

1. Recommended soldering condition

Reflow Soldering (Two times only)		Soldering Iron (One time only)	
Pre-heat:	120~150°C.	Temperature	300°C Max.
Pre-heat time:	120sec. Max.	Soldering time	3sec. Max.
Peak temperature:	260°C Max.		
Soldering time:	5sec. Max.		

2. Number of reflow process shall be less than 2 times, and cooling process to normal temperature is required between the first and the second soldering process.

**LED DISPLAY  
LTD-4830CTB-P**

**7. Recommended Soldering Pattern**

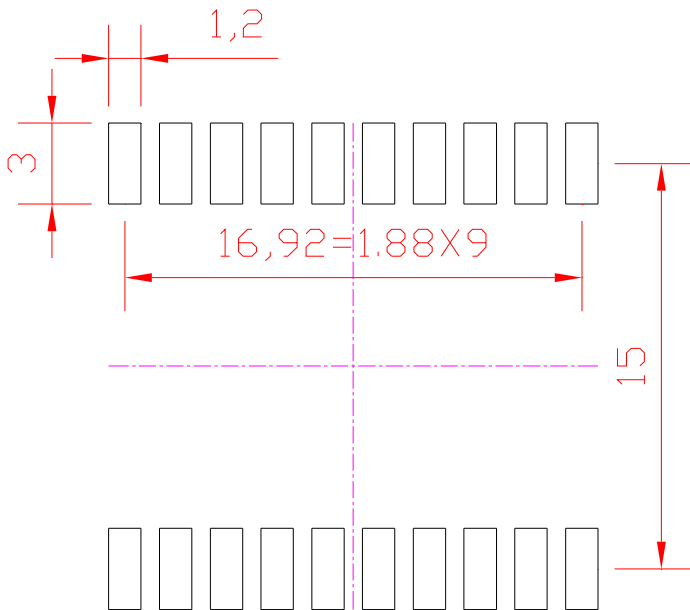

**LED DISPLAY  
LTD-4830CTB-P**

**8. Packing Specification**

**8.1. Packing Reel Dimensions**

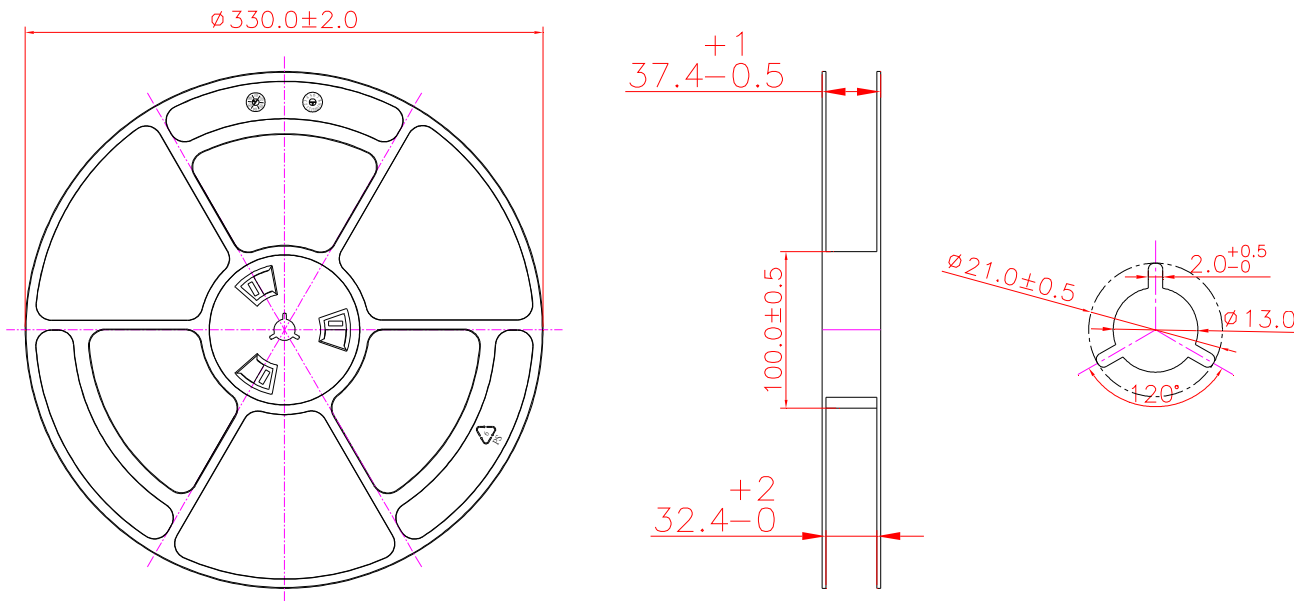

## LED DISPLAY LTD-4830CTB-P

### 8.2. Packing Carrier Dimensions

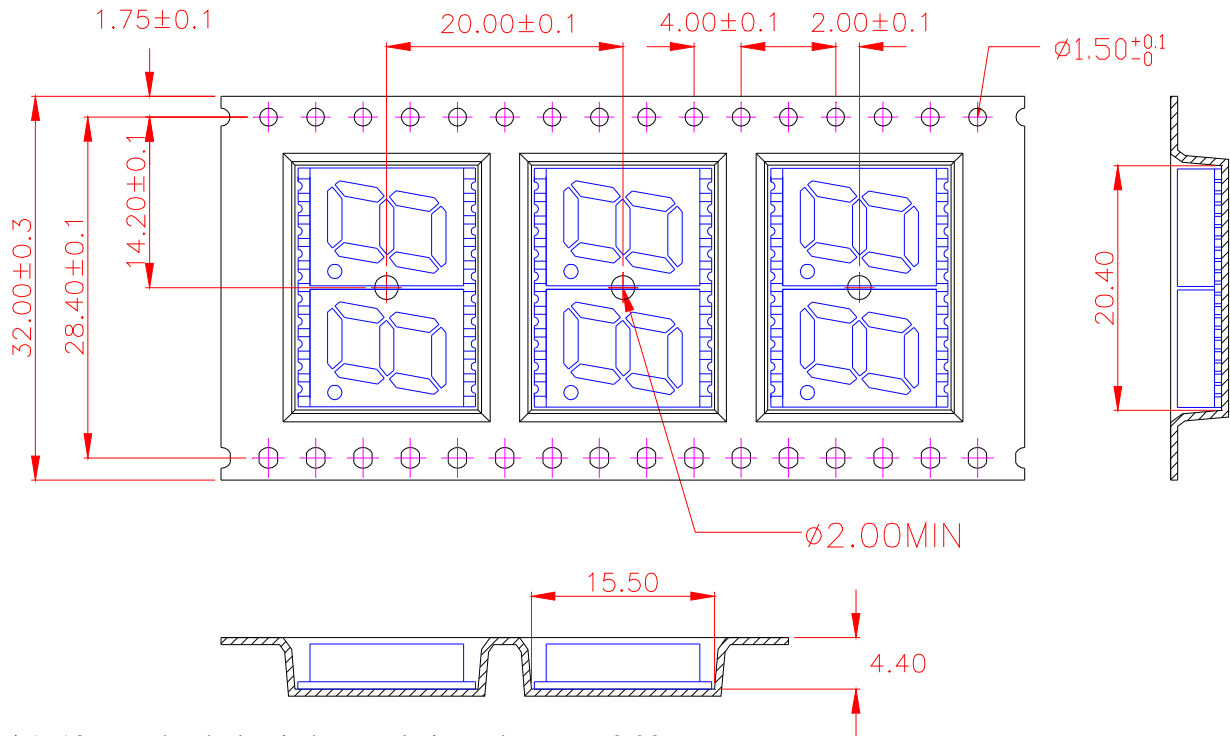

1. 10 sprocket hole pitch cumulative tolerance  $\pm 0.20$ .
2. Carrier camber is within 1 mm in 250 mm.
3. Material : Black Conductive Polystyrene Alloy.
4. All dimensions meet EIA-481-C requirements.
5. Thickness :  $0.30 \pm 0.05 \text{ mm}$ .
6. Packing length per 22" reel : 35.5 Meters.
7. Component load per 13" reel: 550 PCS
8. Minimum packing quantity is 150 PCS for remainders

### 8.3. Trailer part / Leader part

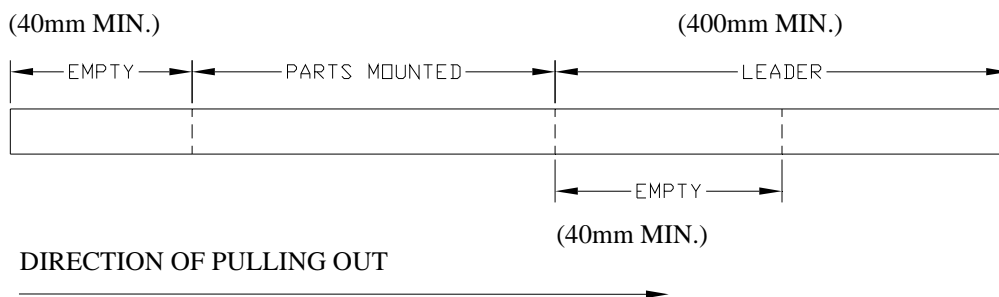

### 9. Moisture Proof Packing

All N/D SMD displays are shipped in moisture proof package. The displays should be stored at 30°C or less and 60% RH or less. Once the package opened, moisture absorption begins.

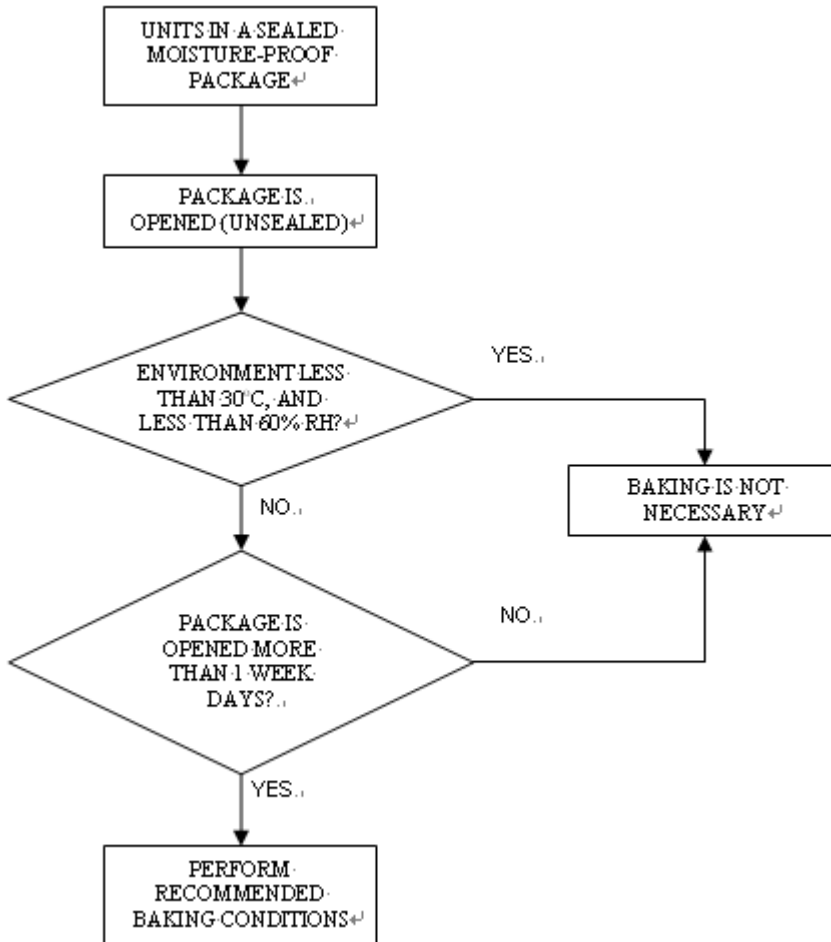

If the parts are not stored in dry conditions, they must be baked before reflow to prevent damage to the parts. Baking should only be done once

Package	Temperature	Time
In Reel	60°C	≥ 48hours
In Bulk	100°C	≥ 4hours
	125°C	≥ 2hours