





Grayhill, Inc.

## 62S11-L9-020CH

Nombor Bahagian:	62S11-L9-020CH
Pengilang / jenama:	Grayhill, Inc.
Penerangan Produk	ROTARY ENCODER OPTICAL 32PPR
Helaian data:	 62S11-L9-020CH.pdf
Status RoHS	 Memimpin percuma / RoHS Compliant
Keadaan Stok	2264 pcs stock
Kapal Dari	Hong Kong
Cara Penghantaran	DHL/Fedex/TNT/UPS/EMS

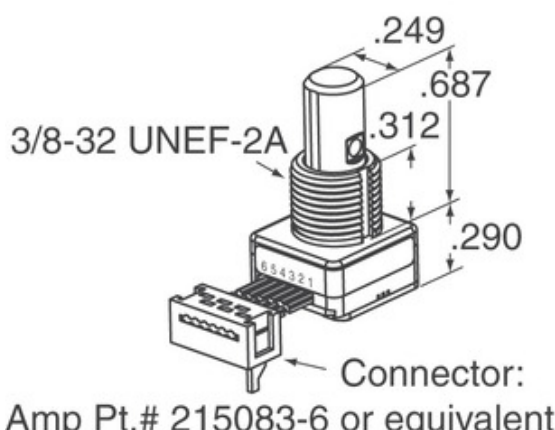

Imej mungkin perwakilan. Lihat spesifikasi untuk butiran produk.

[PERMINTAAN UNTUK SEBUT HARGA](#)



## Spesifikasi 62S11-L9-020CH

NOMBOR BAHAGIAN	62S11-L9-020CH
PENGELUAR	Grayhill, Inc.
PENERANGAN	ROTARY ENCODER OPTICAL 32PPR
STATUS STATUS PERCUMA / ROSH STATUS	Memimpin percuma / RoHS Compliant
KUANTITI TERSEDIA	2264 pcs
LEMBARAN DATA	 62S11-L9-020CH.pdf
VOLTAN - BEKALAN	5V
STYLE PENAMATAN	Cable with Connector
SIRI	62S
PUTARAN LIFE (CYCLES MIN)	1M
DENYUTAN PER REVOLUTION	32
JENIS OUTPUT	Quadrature (Incremental)
NAMA LAIN	62S11L9020CH
ORIENTASI	Vertical
PEMASANGAN JENIS	Panel Mount
TAHAP SENSITIVITI LEMBAPAN (MSL)	1 (Unlimited)
STATUS STATUS PERCUMA / ROSH STATUS	Lead free / RoHS Compliant
JENIS ENCODER	Optical
TURUTAN LAKARAN SASARAN	Yes
DIBINA PADA TUKAR	Yes
JENIS PENGGERAK	1/4" Dia Flatted End

## Tag berkaitan

Grayhill, Inc. 62S11-L9-020CH	Pengedar 62S11-L9-020CH	Pembekal 62S11-L9-020CH
Harga 62S11-L9-020CH	Gambar 62S11-L9-020CH	Imej 62S11-L9-020CH
Datasheet PDF 62S11-L9-020CH	Muat turun Datasheet 62S11-L9-020CH	Datasheet 62S11-L9-020CH
Stok 62S11-L9-020CH	Beli 62S11-L9-020CH	Beli Grayhill, Inc. 62S11-L9-020CH
Grayhill, Inc. 62S11-L9-020CH	Pembekal Grayhill, Inc.	Pengedar Grayhill, Inc.
Grayhill, Inc. 62S11-L9-020CH	Grayhill Inc. 62S11-L9-020CH	

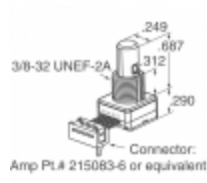
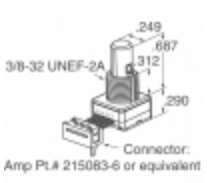
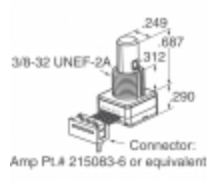
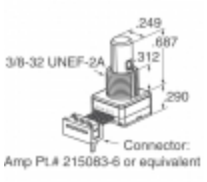
## Produk Berkaitan

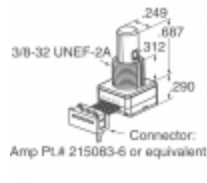
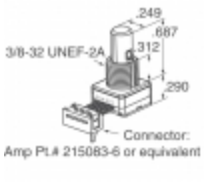
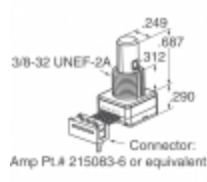
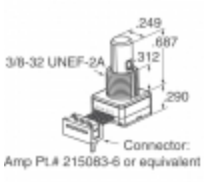
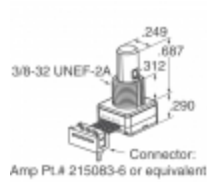
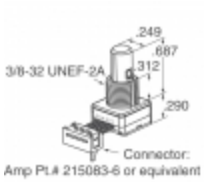
 <p><b>62S11-L9-020S</b> Pengilang: Grayhill, Inc. Penerangan: ROTARY ENCODER OPTICAL 32PPR Dalam stok: 2134 pcs</p> <p><a href="#">RFQ</a></p>	 <p><b>62S11-L5-P</b> Pengilang: Grayhill, Inc. Penerangan: ROTARY ENCODER OPTICAL 32PPR Dalam stok: 2265 pcs</p> <p><a href="#">RFQ</a></p>
 <p><b>62S11-L5-040C</b> Pengilang: Grayhill, Inc. Penerangan: ROTARY ENCODER OPTICAL 32PPR Dalam stok: 1990 pcs</p> <p><a href="#">RFQ</a></p>	 <p><b>62S11-L9-040C</b> Pengilang: Grayhill, Inc. Penerangan: ROTARY ENCODER OPTICAL 32PPR Dalam stok: 1938 pcs</p> <p><a href="#">RFQ</a></p>
 <p><b>62S11-L5-PH</b> Pengilang: Grayhill, Inc. Penerangan: ROTARY ENCODER OPTICAL 32PPR Dalam stok: 2218 pcs</p> <p><a href="#">RFQ</a></p>	 <p><b>62S11-L9-PH</b> Pengilang: Grayhill, Inc. Penerangan: ROTARY ENCODER OPTICAL 32PPR Dalam stok: 1972 pcs</p> <p><a href="#">RFQ</a></p>
 <p><b>62S11-M0-020C</b> Pengilang: Grayhill, Inc. Penerangan: ROTARY ENCODER OPT 32PPR 2" CBL Dalam stok: 1812 pcs</p> <p><a href="#">RFQ</a></p>	 <p><b>62S11-L9-020SH</b> Pengilang: Grayhill, Inc. Penerangan: ROTARY ENCODER OPTICAL 32PPR Dalam stok: 1952 pcs</p> <p><a href="#">RFQ</a></p>
 <p><b>62S11-L5-060C</b> Pengilang: Grayhill, Inc. Penerangan: ROTARY ENCODER OPTICAL 32PPR Dalam stok: 2163 pcs</p> <p><a href="#">RFQ</a></p>	 <p><b>62S11-L9-020C</b> Pengilang: Grayhill, Inc. Penerangan: ROTARY ENCODER OPTICAL 32PPR Dalam stok: 1773 pcs</p> <p><a href="#">RFQ</a></p>
 <p><b>62S11-M0-020SH</b> Pengilang: Grayhill, Inc. Penerangan: ROTARY ENCODER OPT 32PPR 2" CBL Dalam stok: 2051 pcs</p> <p><a href="#">RFQ</a></p>	 <p><b>62S11-L5-050CH</b> Pengilang: Grayhill, Inc. Penerangan: ROTARY ENCODER OPTICAL 32PPR Dalam stok: 2186 pcs</p> <p><a href="#">RFQ</a></p>

Hak Cipta © 2020 Pengedar yang boleh dipercayai komponen elektronik

E-mel: [Info@infinity-electronic.com](mailto:Info@infinity-electronic.com)

Alamat: 17F, Binaan Komersil Gaylord, 114-118 Lockhart Road, Wan Chai, Hong Kong

