





Grayhill, Inc.

62S11-L9-020SH

Nombor Bahagian:	62S11-L9-020SH
Pengilang / jenama:	Grayhill, Inc.
Penerangan Produk	ROTARY ENCODER OPTICAL 32PPR
Helaian data:	 62S11-L9-020SH.pdf
Status RoHS	 Memimpin percuma / RoHS Compliant
Keadaan Stok	1952 pcs stock
Kapal Dari	Hong Kong
Cara Penghantaran	DHL/Fedex/TNT/UPS/EMS

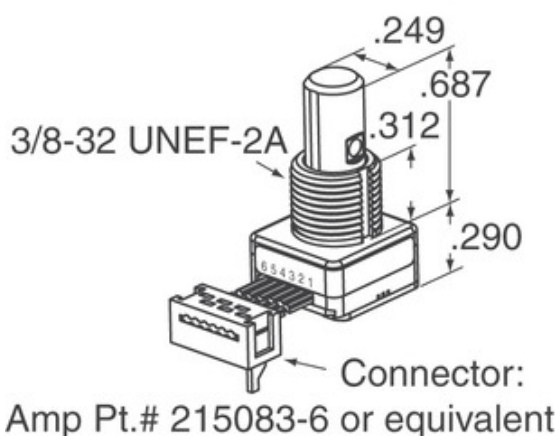

Imej mungkin perwakilan. Lihat spesifikasi untuk butiran produk.







Spesifikasi 62S11-L9-020SH

NOMBOR BAHAGIAN	62S11-L9-020SH
PENGLUAR	Grayhill, Inc.
PENERANGAN	ROTARY ENCODER OPTICAL 32PPR
STATUS STATUS PERCUMA / ROSH STATUS	Memimpin percuma / RoHS Compliant
KUANTITI TERSEDIA	1952 pcs
LEMBARAN DATA	 62S11-L9-020SH.pdf
VOLTAN - BEKALAN	5V
STYLE PENAMATAN	Cable Leads
SIRI	62S
PUTARAN LIFE (CYCLES MIN)	1M
DENYUTAN PER REVOLUTION	32
JENIS OUTPUT	Quadrature (Incremental)
NAMA LAIN	62S11L9020SH
ORIENTASI	Vertical
PEMASANGAN JENIS	Panel Mount
TAHAP SENSITIVITI LEMBAPAN (MSL)	1 (Unlimited)
STATUS STATUS PERCUMA / ROSH STATUS	Lead free / RoHS Compliant
JENIS ENCODER	Optical
TURUTAN LAKARAN SASARAN	Yes
DIBINA PADA TUKAR	Yes
JENIS PENGGERAK	1/4" Dia Flatted End

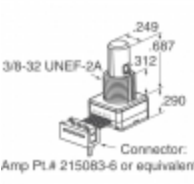
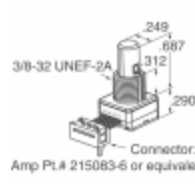
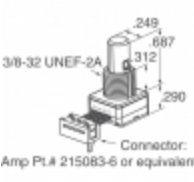
Tag berkaitan

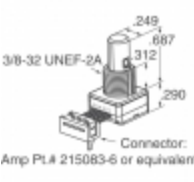
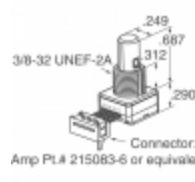
Grayhill, Inc. 62S11-L9-020SH	Pengedar 62S11-L9-020SH	Pembekal 62S11-L9-020SH
Harga 62S11-L9-020SH	Gambar 62S11-L9-020SH	Imej 62S11-L9-020SH
Datasheet PDF 62S11-L9-020SH	Muat turun Datasheet 62S11-L9-020SH	Datasheet 62S11-L9-020SH
Stok 62S11-L9-020SH	Beli 62S11-L9-020SH	Beli Grayhill, Inc. 62S11-L9-020SH
Grayhill, Inc. 62S11-L9-020SH	Pembekal Grayhill, Inc.	Pengedar Grayhill, Inc.
Grayhill, Inc. 62S11-L9-020SH	Grayhill Inc. 62S11-L9-020SH	

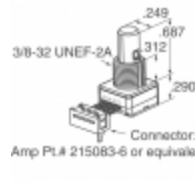
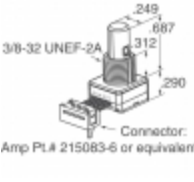
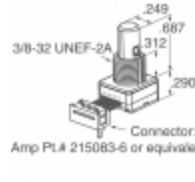
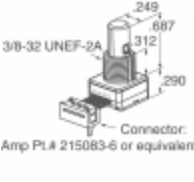
Produk Berkaitan

 <p>62S11-L9-040C Pengilang: Grayhill, Inc. Penerangan: ROTARY ENCODER OPTICAL 32PPR Dalam stok: 1938 pcs RFQ</p>	 <p>62S11-M0-020C Pengilang: Grayhill, Inc. Penerangan: ROTARY ENCODER OPT 32PPR 2" CBL Dalam stok: 1812 pcs RFQ</p>
 <p>62S11-L9-020S Pengilang: Grayhill, Inc. Penerangan: ROTARY ENCODER OPTICAL 32PPR Dalam stok: 2134 pcs RFQ</p>	 <p>62S11-L5-PH Pengilang: Grayhill, Inc. Penerangan: ROTARY ENCODER OPTICAL 32PPR Dalam stok: 2218 pcs RFQ</p>
 <p>62S11-M0-020SH Pengilang: Grayhill, Inc. Penerangan: ROTARY ENCODER OPT 32PPR 2" CBL Dalam stok: 2051 pcs RFQ</p>	 <p>62S11-L9-020CH Pengilang: Grayhill, Inc. Penerangan: ROTARY ENCODER OPTICAL 32PPR Dalam stok: 2264 pcs RFQ</p>
 <p>62S11-M0-040CH Pengilang: Grayhill, Inc. Penerangan: ROTARY ENCODER OPT 32PPR 2" CBL Dalam stok: 1915 pcs RFQ</p>	 <p>62S11-L5-060C Pengilang: Grayhill, Inc. Penerangan: ROTARY ENCODER OPTICAL 32PPR Dalam stok: 2163 pcs RFQ</p>
 <p>62S11-L5-P Pengilang: Grayhill, Inc. Penerangan: ROTARY ENCODER OPTICAL 32PPR Dalam stok: 2265 pcs RFQ</p>	 <p>62S11-M0-030CH Pengilang: Grayhill, Inc. Penerangan: ROTARY ENCODER OPTICAL 32PPR Dalam stok: 2151 pcs RFQ</p>
 <p>62S11-L9-020C Pengilang: Grayhill, Inc. Penerangan: ROTARY ENCODER OPTICAL 32PPR Dalam stok: 1773 pcs RFQ</p>	 <p>62S11-L9-PH Pengilang: Grayhill, Inc. Penerangan: ROTARY ENCODER OPTICAL 32PPR Dalam stok: 1972 pcs RFQ</p>

Hak Cipta © 2020 Pengedar yang boleh dipercayai komponen elektronik

E-mel: Info@infinity-electronic.com

Alamat: 17F, Binaan Komersil Gaylord, 114-118 Lockhart Road, Wan Chai, Hong Kong

